

GV-AVD4710 4MP H.265 4.3x Zoom Super Low Lux WDR Pro IR Vandal Proof IP

Dome



- 1/3" progressive scan super low lux CMOS
- Min. illumination at 0.005 lux
- Triple streams from H.265, H.264 and MJPEG
- Up to 20 fps at 2592 x 1520, 25 fps at 2560 x 1440 and 30 fps at 2048 x 1520
- Motorized varifocal lens for remote focus / zoom adjustment
- Intelligent IR
- IR distance up to 30 m (100 ft)
- Day and Night function (with removable IR-cut filter)
- Vandal resistance (IK10 for metal casing)
- Ingress protection (IP67)
- 3-axis mechanism (pan / tilt / rotate)
- DC 12V / PoE (IEEE 802.3af)
- Built-in micro SD card slot (SD / SDHC / SDXC / UHS-I, Class 10) for local storage
- Two-way audio
- Wide Dynamic Range Pro (WDR Pro)
- Defog
- 3D noise reduction
- Motion detection
- Text overlay
- Privacy mask
- Tampering Alarm
- ONVIF (Profile G, S, T) conformant

Introduction

The Vandal Proof IP Dome is an outdoor camera designed with IK10 vandal resistance and IP67 ingress protection. GV-AVD4710 supports H.265 video codec to achieve better compression ratio while maintaining high quality pictures at reduced network bandwidths. The camera is equipped with an automatic IR-cut filter and IR LEDs for day and night surveillance. Adjustable in 3 axis (pan, tilt and rotate), it offers an entry-level surveillance solution with all the essential features and excellent image quality.

Active Tampering Alarm

Tampered



Focus Change



Camera Shift



Dimensions

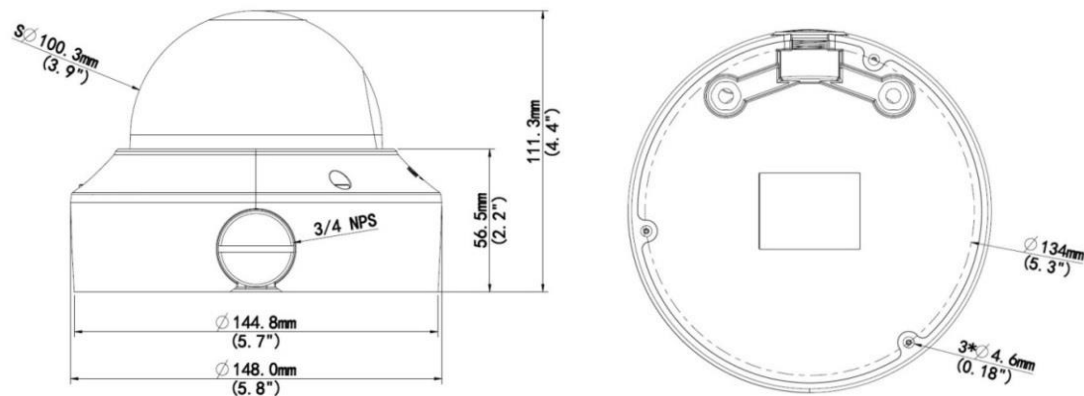

Specifications

Camera		
Image Sensor	1/3" progressive scan super low lux CMOS	
Picture Elements	2592(H) x 1520 (V)	
Minimum Illumination	Color	0.005 Lux (F1.4, AGC ON)
	IR On	0 Lux
Shutter Speed	Automatic, Manual (1/6 ~ 1/100000 sec)	
White Balance	Automatic, Manual	
Gain Control	Automatic, Manual	
S/N Ratio	55 dB	
WDR Pro	Yes	
Dynamic Range	Up to 120 dB	
Lens		
Megapixel	4 MP	
Day/Night	Yes (with removable IR-cut filter)	
Focal Length	2.8 ~ 12 mm	
Lens Type	Motorized varifocal lens	
Maximum Aperture	F/1.4	
Mount	$\varnothing 14$ mm	
Horizontal FOV	91° ~ 27°	
Operation	Focus	Automatic / Manual
	Zoom	4.3x Optical Zoom
	Iris	Fixed
IR LED Quantity	2 IR LEDs	
Max. IR Distance	30 m (100 ft)	
Operation		
Video Compression	H.265, H.264, MJPEG	
Video Streaming	Triple streams	
Frame Rate	20 fps at 2592 x 1520, 25 fps at 2560 x 1440, 30 fps at 2048 x 1520 (60 / 50 Hz) * The frame rate and the performance may vary depending on the number of connections and data bitrates (different scenes).	
Video Analytics	Motion Detection, Tampering Alarm, Audio Detection, Cross Line, Intrusion, Object Moving, Object Left, Defocus, Scene Change, Face Detection, People Counting *Tampering Alarm, Audio Detection, Cross Line, Intrusion, Object Moving, Object Left, Defocus, Scene Change, Face Detection and People Counting are only accessible through the camera's Web interface, which can be used to trigger alerts such as e-mail and FTP	
Image Setting	Brightness, Contrast, Saturation, Sharpness, Flicker-less, Image Orientation (Flip, Mirror, 0°, 90°, 180°, 270°-including Corridor format)	
Audio Compression	G.711	
Audio Support	Two-way Audio (external microphone and speaker required)	
Digital I/O	Input	1 Input, dry contact, NO / NC
	Output	1 Relay Output (1A 30V DC / 0.3A 125V AC)

Video Resolution		
Video Resolution	Main Stream	2592 x 1520, 2560 x 1440 (Default), 2048 x 1520, 1920 x 1080
	Sub Stream	1920 x 1080, 1280 x 720, 720 x 576, 704 x 288, 640 x 360 (Default), 352 x 288
	Third Stream (Closed by Default)	720 x 576, 704 x 288, 640 x 360, 352 x 288
Network		
Interface	10/100 Ethernet	
Ethernet Protocol	802.1x, ARP, DHCP, DDNS, DNS, DynDNS, FTP, HTTP, HTTPS, ICMP, IGMP, IPv4, NTP, PPPoE, QoS, RTCP, RTP, RTSP, SMTP, SNMP, TCP, UDP, UPnP, ONVIF (Profile G, S, T)	
Mechanical		
Camera Angle Adjustment	Pan	0° ~ 360°
	Tilt	0° ~ 80°
	Rotate	0° ~ 360°
Connectors	Power	DC Jack, PoE
	Ethernet	RJ-45
	Audio	1 in (Audio In Wire); 1 out (Audio Out Wire) *The Audio In port only supports microphones with power supply.
	Digital I/O	4-pin terminal block pitch 3.5 mm (0.14")
	Local Storage	Micro SD card slot (SD / SDHC / SDXC / UHS-I, Class 10) * UHS-II card types are not supported.
	TV-Out	BNC connector
General		
Environment Temperature	-40°C ~ 60°C (-22°F ~ 140°F)	
Humidity	0% to 95% (no condensation)	
Power Source	12V DC / PoE (IEEE 802.3af)	
Max. Power Consumption	7.2 W	
Dimension	Ø148 x 111.3 mm (Ø5.8" x 4.4")	
Weight	0.75 kg (1.7 lb)	
Ingress Protection	IP67	
Vandal Resistance	IK10 for metal casing	
Regulatory	CE, FCC, RoHS compliant	
Web Interface		
Installation Management	Web-based configuration	
Maintenance	Firmware upgrade through Web Browser or Utility	
Access from Web Browser	Live View, Video Recording, Change Video Quality, Bandwidth Control, Image Snapshot, Text Overlay, Image Masking	
Language	Czech, English, French, German, Hungarian, Italian, Japanese, Polish, Portuguese, Russian, Spanish, Traditional Chinese	
Applications		
Network Storage	GV-DVR / NVR (V8.7.4.0), GV-VMS (V16.11.0.0), GV-Control Center (V3.5.0.0), GV-Edge Recording Manager (V1.3.0.0), GV-Recording Server / Video Gateway (V1.4.0.0), GV-Redundant / Failover Server (V1.1.0.0)	
Smart Device Access	GV-Eye for iOS and Android	
Live Viewing	Browser (IE, Edge, Chrome, Firefox, Safari), Mobile App	

Note:









1. It is required to apply patch files to all the supported software.
2. Do not use clothes or any ordinary material to clean the camera cover since they may result in scratches.
3. Specifications are subject to change without notice.



Packing List

- | | |
|------------------------------------|-------------------|
| 1. GV-AVD4710 IR Vandal Proof Dome | 5. Torx Wrench |
| 2. Waterproof Rubber Set | 6. Download Guide |
| 3. Screw Kit | 7. Warranty Card |
| 4. Drill Template Paster | |

Note: Power adapters can be purchased upon request.

Accessories

Model No.	Name		Details
GV-Mount107 (must be used with GV-Mount212-2)	Pendant Bracket		Dimensions: \varnothing 120 x 334 mm (\varnothing 4.72" x 13.15") Weight: 0.74 kg (1.63 lb)
GV-Mount211-2	Wall Mount and Junction Box		Dimensions: \varnothing 253 x 125 x 125 mm (\varnothing 10" x 4.9" x 4.9") Weight: 0.92 kg (2.02 lb)
GV-Mount212-2	Wall Box Mount		Dimensions: \varnothing 145 x 40 mm (\varnothing 5.7" x 1.6") Weight: 0.24 kg (0.5lb)
GV-Mount300-2	Convex Corner Mount		Dimensions: 137 x 233 x 160 mm (5.4" x 9.17" x 6.3") Weight: 1.65 kg (3.64 lb)
GV-Mount310-2	Concave Corner Mount		Dimensions: 111.2 x 369.9 x 210 mm (2.6" x 11.4" x 6.6") Weight: 1.65 kg (3.64 lb)
GV-Mount420 (must be used with GV-Mount211-2)	Pole Mount Bracket		Dimensions: \varnothing 120 x 120 x 53.4 mm (\varnothing 4.7" x 4.7" x 2.1") Weight: 0.45 kg (0.99 lb) Steel Strap Diameter: \varnothing 67 ~ 127 mm (\varnothing 2.6" ~ 5")
GV-Mount606	In-Ceiling Mount		Dimensions: \varnothing 235 x 63 mm (\varnothing 9.3" x 2.5") In-ceiling hole: \varnothing 195 mm (\varnothing 7.67") Weight: 0.49 kg (1.1 lb)
GV-Mount704 (must be used with GV-Mount107)	Extension Tube		Dimensions: \varnothing 3.5 x 10 or 20 or 30 or 50 cm (\varnothing 1.38 x 3.9 or 7.9 or 11.8 or 19.7") Weight: 225g or 360g or 500g or 780g (0.5 lb or 0.79 lb or 1.1 lb or 1.72 lb)

<p>GV-Mount921 (for standard US single and double gang boxes only)</p>	<p>Power Box Mount Bracket</p>		<p>Dimensions: Ø 145 x 13 mm (Ø 5.7" x 0.5") Weight: 0.13 kg (0.29 lb)</p>
<p>GV-PA191</p>	<p>Power over Ethernet (PoE) Adapter</p>		<p>The GV-PA191 is a Power over Ethernet (PoE) adapter designed to provide power to the IP device through a single Ethernet cable.</p>
<p>GV-POE Switch</p>		<p>The GV-POE Switch is designed to provide power along with network connection for IP devices. The GV-POE Switch is available in various models with different numbers and types of ports.</p>	
<p>Power Adapter</p>		<p>Contact our sales representatives for the countries and areas supported.</p>	