

## GV-EBD4704 4MP H.265 Super Low Lux WDR Pro IR Eyeball Dome IP Camera



- 1/3" progressive scan super low lux CMOS sensor
- Dual streams from H.265, H.264 or MJPEG
- Min. illumination at 0.003 lux
- Up to 30 fps at 2688 x 1520
- Intelligent IR
- Day and night function (with removable IR-cut filter)
- Wide Dynamic Range Pro (WDR Pro)
- IR distance up to 30 m (100 ft)
- Built-in microphone
- Built-in micro SD card slot (SD / SDHC / SDXC / UHS-I) for local storage
- 3-axis mechanism (pan / tilt / rotate)
- Ingress protection (IP67)
- DC 12V / PoE (IEEE 802.3af)
- Defog
- 3D noise reduction
- Motion detection
- Tampering alarm
- Text overlay
- Privacy mask
- 12 languages supported
- ONVIF (Profile G, S, T) conformant

### Introduction

GV-EBD4704 is an outdoor, network camera equipped with an automatic IR-cut filter and an IR LED for day and night surveillance. The camera adheres to IP67 standards. The camera supports H.265 video codec to achieve better compression ratio while maintaining high quality pictures at reduced network bandwidths. With its WDR Pro, it can process scenes with contrasting intensity of lights and produce clear image.

### Active Tampering Alarm

Tampered



Focus Change



Camera Shift



### Dimensions

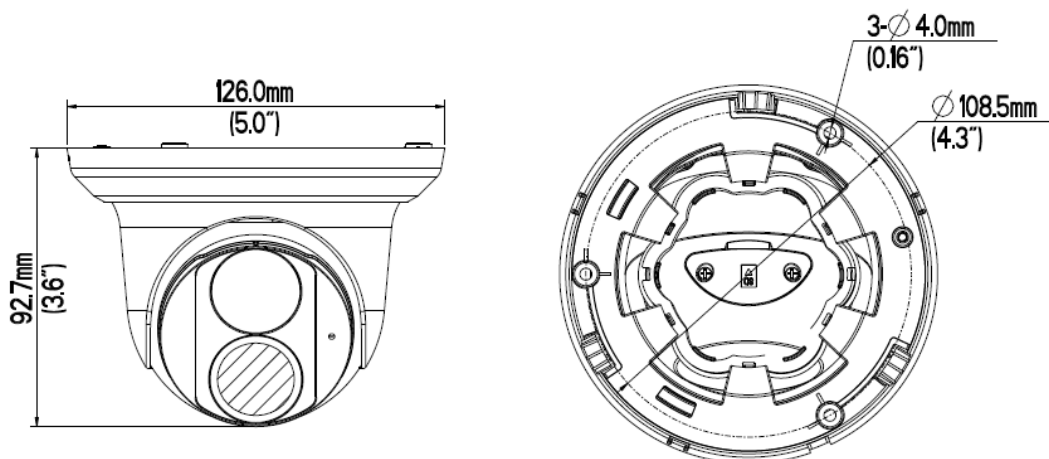

## Specifications

Camera					
Image Sensor		1/3" progressive scan super low lux CMOS			
Picture Elements		2688 (H) x 1520 (V)			
Minimum Illumination	Color	0.003 Lux (F1.6, AGC ON)			
	IR ON	0 Lux			
Shutter Speed		Auto / Manual (1 ~ 1/100000s )			
White Balance		Auto / Manual			
Gain Control		Auto / Manual			
S/N Ratio		56 dB			
WDR Pro		Yes			
Dynamic Range		120 dB			
Optical Lens					
Megapixel		Yes			
Day / Night		Yes (with removable IR-cut filter)			
Lens Type		Fixed			
Focal Length		2.8 mm			
Maximum Aperture		F/1.6			
Mount		M12			
Horizontal FOV		101°			
Operation	Focus	Fixed			
	Zoom	Fixed			
	Iris	Fixed			
IR LED Quantity		1 IR LED			
Max. IR Distance		30 m (100 ft)			
DORI		Detect	Observe	Recognize	Identify
Lens	2.8 mm	63 m (206.7 ft)	25.2 m (82.7 ft)	12.6 m (41.3 ft)	6.3 m (20.7 ft)
Operation					
Video Compression		H.265, H.264, MJPEG			
Video Streaming		Dual streams from H.265, H.264 or MJPEG			
Frame Rate		30 fps at 2688 x 1520, 30 fps at 2560 x 1440, 30 fps at 2304 x 1296 (60 / 50 Hz) *The frame rate and performance may vary depending on the number of connections and data bitrates (different scenes).			
Video Analytics		Motion Detection, Tampering Alarm , Audio Detection , Cross Line, Intrusion *Tampering Alarm, Audio Detection, Cross Line, Intrusion are only accessible through the camera's Web interface, which can be used to trigger alerts such as e-mail and FTP			
Image Setting		Brightness, Contrast, Saturation, Sharpness, Flicker-less, Image Orientation (Flip, Mirror, 0°, 90°, 180°, 270°-including Corridor format)			
Audio Compression		G.711			
Audio Support		One-way Audio			
Video Resolution					
Main Stream		2688 x 1520 (Default), 2560 x 1440, 2304 x 1296, 1920 x 1080, 1280 x 720			
Sub Stream		1280 x 720, 720 x 576, 640 x 480, 640 x 360 (Default)			
Network					
Interface		10/100 Ethernet			
Protocol		802.1x, ARP, DHCP, DDNS, DNS, DynDNS, FTP, HTTP, HTTPS, ICMP, IGMP, IPv4, IPv6, NTP, PPPoE, QoS, RTCP, RTP, RTSP, SMTP, SNMP, TCP, UDP, UPnP, ONVIF (Profile G, S, T)			
Mechanical					
Camera Angle Adjustment	Pan	0° ~ 360°			
	Tilt	0° ~ 90°			
	Rotate	0° ~ 360°			

Connectors	Power	DC Jack (DC 12V, 1.25A), PoE
	Ethernet	RJ-45
	Audio	1 In (built-in microphone)
	Local Storage	Micro SD card slot (SD/SDHC/SDXC/UHS-I, Class 10) *UHS-II card type is not supported.
<b>General</b>		
Environment Temperature	Start-up	-30°C ~ 60°C (-22°F ~ 140°F)
	Operation	
Humidity	0% ~ 95% (no condensation)	
Power Source	12V DC / PoE (IEEE 802.3af)	
Max. Power Consumption	6 W	
Dimensions	Ø 126 x 92.7 mm (Ø 5.0" x 3.6")	
Weight	0.45 kg (0.99 lb)	
Ingress Protection	IP67	
Certification	CE, FCC, RoHS, UL compliant	
<b>Web Interface</b>		
Installation Management	Web-based configuration	
Maintenance	Firmware upgrade through Web Browser or GV-IP Device Utility	
Access from Web Browser	Live View, Video Recording, Change Video Quality, Bandwidth Control, Image Snapshot, Defog, Text Overlay, Image Masking	
Language	Czech, English, French, German, Hungarian, Italian, Japanese, Polish, Portuguese, Russian, Spanish, Traditional Chinese	
<b>Applications</b>		
Software Supported	GV-VMS (V17.4.1 / V18.2.1), GV-DVR / NVR (V8.9.1), GV-Control Center (V3.8.0), GV-Recording Server / Video Gateway (V2.0.0), GV-Edge Recording Manager Win version (V2.0.0), GV-Redundant / Failover Server (V1.2.0), GV-Mobile Server (V1.5.0.0)	
Live Viewing	Browser (IE, Edge, Chrome, Firefox, Safari), Mobile App	



**Note:**





1. It is required to apply patch files to some of the supported software.
2. Do not use clothes or any ordinary material to clean the camera cover since they may result in scratches.
3. Specifications are subject to change without notice.

**Packing List**

- |                            |                          |
|----------------------------|--------------------------|
| 1. GV-EBD4704 Eyeball Dome | 4. Drill Template Paster |
| 2. Waterproof Rubber Set   | 5. Download Guide        |
| 3. Screw kit               | 6. Warranty Card         |

**Accessories**

Model No.	Name		Details
GV-Mount107 (must be used with GV-Mount212P)	Pendant Bracket		Dimensions: Ø 120 x 334 mm (Ø 4.72" x 13.15") Weight: 0.74 kg (1.63 lb)
GV-Mount211P	Wall Mount and Junction Box		Dimensions: Ø 233 x 125 x 125 mm (Ø 9.2" x 4.9" x 4.9") Weight: 1 kg (2.2 lb)
GV-Mount212P	Wall Box Mount		Dimensions: Ø 126 x 36 mm (Ø 5.0" x 1.4") Weight: 0.22 kg (0.48 lb)

GV-Mount300-2	Convex Corner Mount		Dimensions: 137 x 233 x 160 mm (5.4" x 9.17" x 6.3") Weight: 1.65 kg (3.64 lb)
GV-Mount310-2	Concave Corner Mount		Dimensions: 111.2 x 369.9 x 210 mm (2.6" x 11.4" x 6.6") Weight: 1.65 kg (3.64 lb)
GV-Mount420 (must be used with GV-Mount211P)	Pole Mount Bracket		Dimensions: $\varnothing$ 120 x 120 x 53.4 mm ( $\varnothing$ 4.7" x 4.7" x 2.1") Weight: 0.45 kg (0.99 lb) Steel Strap Diameter: $\varnothing$ 67 ~ 127 mm ( $\varnothing$ 2.6" ~ 5")
GV-Mount704 (must be used with GV-Mount107)	Extension Tube		Dimensions: $\varnothing$ 3.5 x 10 or 20 or 30 or 50 cm ( $\varnothing$ 1.38 x 3.9 or 7.9 or 11.8 or 19.7") Weight: 225 g or 360 g or 500 g or 780 g (0.5 lb or 0.79 lb or 1.1 lb or 1.72 lb)
GV-PA191	Power over Ethernet (PoE) Adapter		GV-PA191 is a Power over Ethernet (PoE) adapter designed to provide power to the IP device through a single Ethernet cable.
GV-PoE Switch	GV-PoE Switch is designed to provide power along with network connection for IP devices. GV-PoE Switch is available in various models with different numbers and types of ports		
Power Adapter	Contact our sales representatives for the countries and areas supported.		